

SHIMPO-WEST

RK-2 Potter's Wheel

INSTRUCTION MANUAL

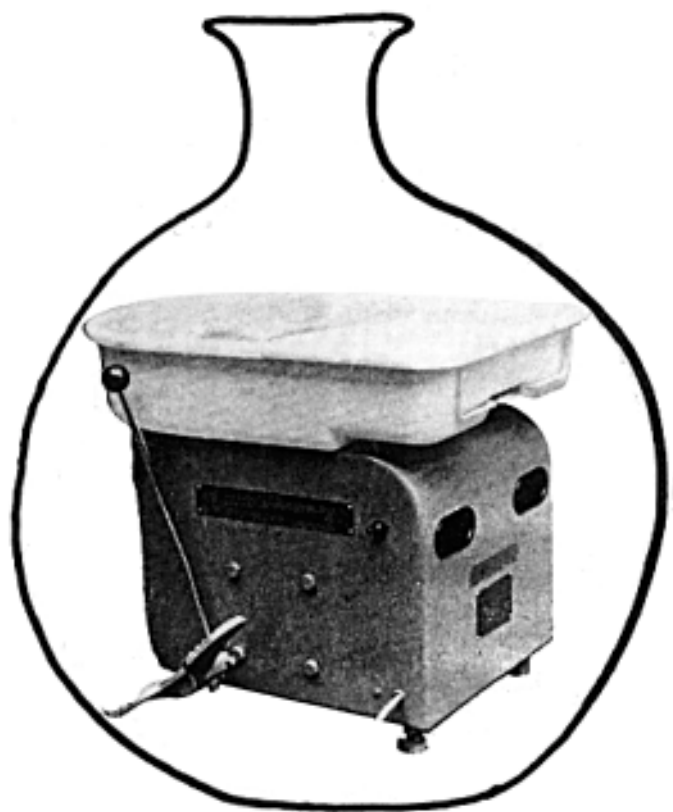

SHIMPO INDUSTRIAL CO., LTD.

WITH THE WHEEL
YOU SHOULD HAVE RECEIVED

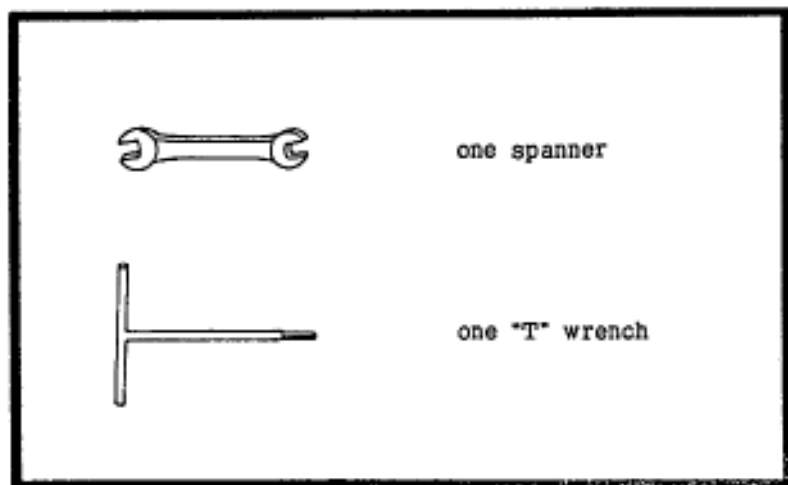

CONSTRUCTION AND MAIN PARTS

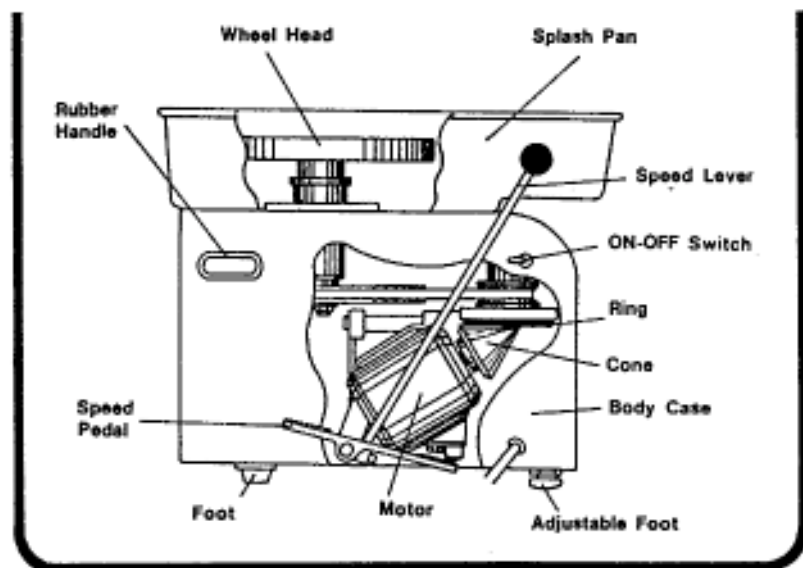

SETTING UP

In advance to operation, follow instructions ①-③ to set up the wheel.

- ① Place wheel on end as shown in Draw. No. 1-1

DRAW. No. 1-1

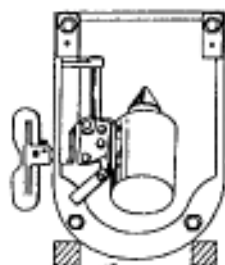

- ② Remove the one red bolt and washer (arrow mark) with attached spanner. (Draw. No. 1-2)

Do not operate the wheel before removing the red bolt and washer. These parts are provided to hold the motor in place during transit only.

Keep these parts for future use. Whenever transporting the wheel, the motor should be re-secured.

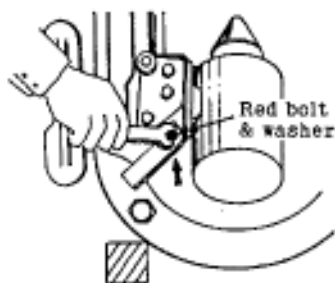

DRAW. No. 1-2

- ③ Remove plastic coating over the wheel head. (Draw. No. 2)

The wheel head is coated with special plastics. To remove this, pull off the string running across the middle of the wheel head and peel away the plastics.

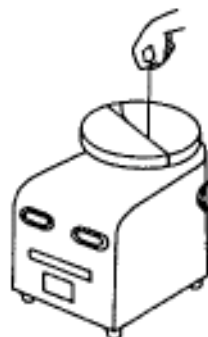

DRAW. No. 2

HOW TO SET SPLASH PAN

To set two pieces of plastic splash pan, take **THREE STEPS** illustrated below :

STEP 1

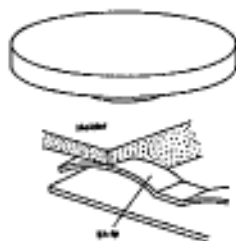
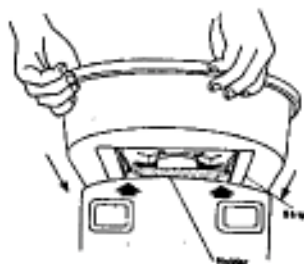

※Engage strip on the base of splash pan with groove of holder.

STEP 2

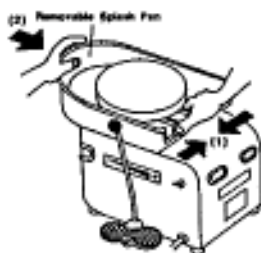

※Slide splash pan forward (2), holding rims (1).

STEP 3

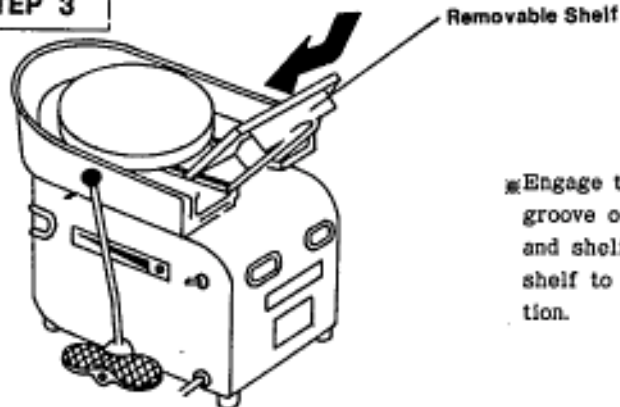

※Engage the guide and groove of splash pan and shelf, and slide shelf to fix in position.

To remove pan, reverse the preceding operations.

HOW TO CHANGE DIRECTION OF ROTATION

Clockwise rotation is possible if you require.

To do this:

1. Place pedal to "STOP" position and SWITCH OFF.
2. Set the wheel on end as shown in Draw. No. 3.
3. Change the connection of wires as follows:

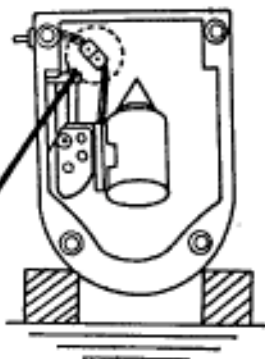

DRAW. No. 3

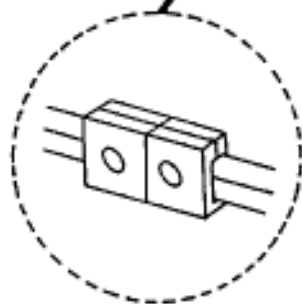

Wire connector;
controls the
direction of
rotation

PROCEDURE: A→C

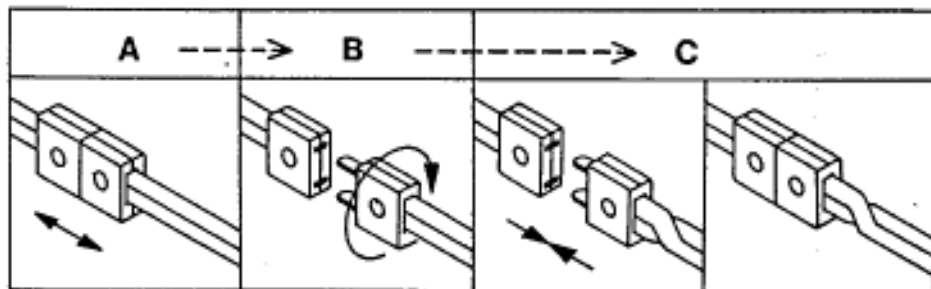

WHEN NOT IN USE BE SURE MOTOR IS TURNED OFF

Although the pedal may be in the "STOP" position, the motor may still be running. Never leave the pedal in any position but "STOP" when the motor is off. The pressure of the steel cone on the rubber ring will create a temporary indentation that will cause a rumbling sound when the wheel is turned on. If this does occur, both the sound and the imprint will work themselves out in a few moments.

WHEN WOBBLING

The RK-2 has one adjustable foot. To adjust in case of wobble, loosen top nut of right rear foot and screw foot up or down as required, then tighten top nut.

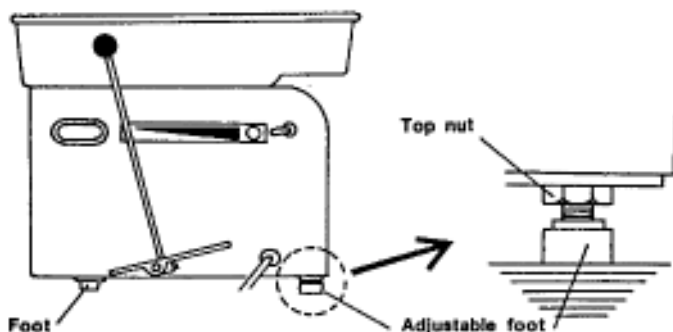

WHEN REPLACING AN INTERIOR
PART OR ADJUSTING, ALWAYS
REMOVE THE SPLASH PAN AND
SET THE WHEEL ON END AS
IN DRAW. NO. 4.

POWER ADJUSTMENT

Power may be increased or decreased by adjusting the pressure between the ring and the cone on the Ringcone Drive System.

To do this:

- 1 With the spanner provided with the wheel, loosen the three bolts illustrated in Draw. No. 4.
- 2 Slide the casting and motor on the shaft (move it towards the pedal to increase power and away to decrease power). If you move the unit too far up, it will tighten the pressure between the cone and ring to a point where the variable speed control will not work. Make slight adjustments instead of one complete move.
- 3 Retighten the three bolts.

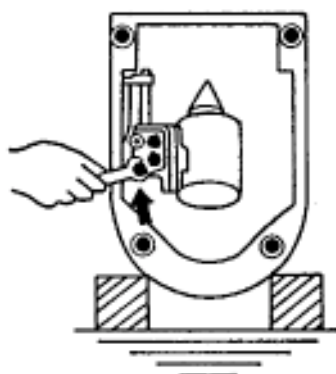

DRAW. No. 4

HOW TO REPLACE THE RING

If you find that your wheel is losing power, this probably means that the rubber drive ring is worn. (Always check your power adjustment before changing the ring).

To replace the ring remove the four pan head screws and the stop board (Draw. No. 5). Slip the old ring off and replace with a new ring.

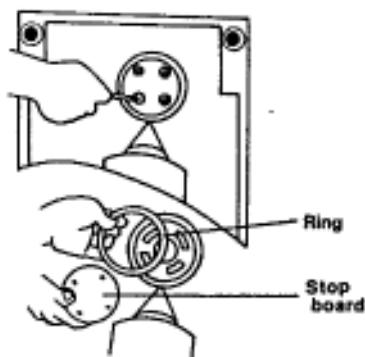

DRAW. No. 5

SPECIFICATIONS

- Wheel head speed: 0~240 r.p.m.
- Direction: Counter-clockwise
- Material of wheel head: Light alloy casting
- Motor: 200W(1/4 Hp), 115V, 60 Hz,
Single phase
Desired voltages are available.
- Dimensions: Length 622 mm (24 31/64")
Width 528 mm (20 25/32")
Height 499 mm (19 41/64")
Diameter of wheel head
300 mm (11 3/4")
- Weight 61 Kg. (134 lbs.)

SHIMPO CERAMICS DIVISION

NIDEC-SHIMPO AMERICA CORPORATION

1701 Glenlake Ave. • Itasca, IL 60143-1072

Ph: 630-924-7138 • Fax: 630-924-7639